

# 2024 NEW PRODUCT CATALOG

[ Show Yourself 2023 \*Gold Prize ]  
Raccoon Squad / AUSTRIA



# G&G ARMAMENT

[WWW.GUAY2.COM](http://WWW.GUAY2.COM)

G&G ARMAMENT  
ARMS, GEAR & ACCESSORIES

# THIS IS PAI

## G&G Armament patented Hop-Up chamber design elaboration

The Hop-Up Chamber is the core component of the airsoft gun for ballistic accuracy and range. The latest patented Hop-Up Chamber launched by G&G Armament this year is different from any other product on the market and can be used with various weights of BBs, even up to 0.4g, and still achieve optimal trajectory and range. The main visual design of this patented Hop-Up Chamber is pictured below:

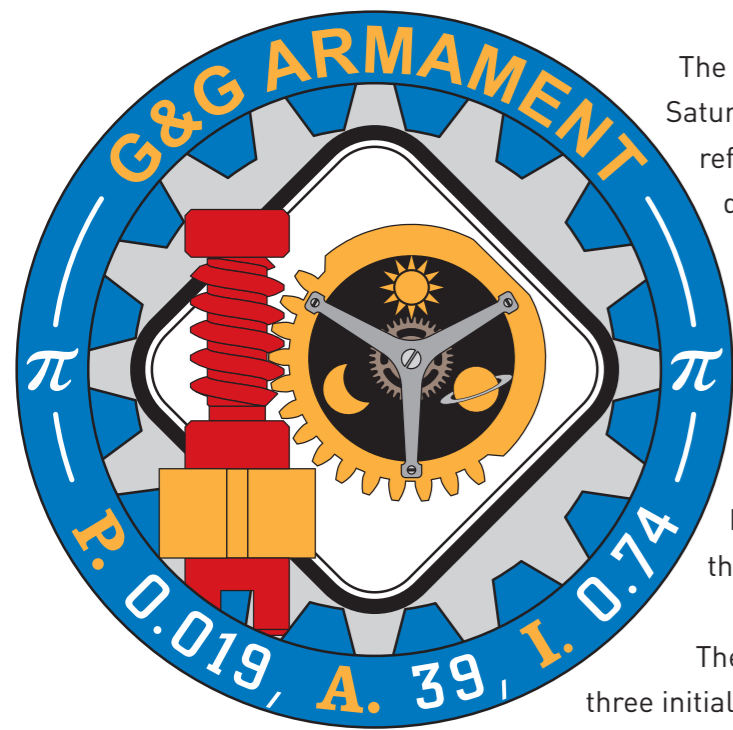

The central graphic depicts the core parts of the patented Hop-Up Chamber. The planetary icons (Sun, Saturn, Moon) represent the mystery of planetary movement. The different masses of each celestial mass reflect the range of BB weights, while their varying orbital speeds relate to the BB rotation speeds at different masses after passing through the Hop-Up chamber. On the bottom of the outer ring, **P.** is the initial for Precision, and the unit of this number 0.019 describes the distance in millimeters that the top-down piece moves with each dial adjustment. This is just one example of how the core parts are very precise with finely tuned adjustment features. **A.** is the initial for Accuracy, and the number 39 is the total number of dial adjustments that can be operated, showing the most accurate ballistics can be achieved by fine tuning. **I.** is the initial for Innovation, and the number 0.74 represents the total travel distance in millimeters (0.019mm x 39 dials), which demonstrates how this innovative design operates through very precise parts with fine tuning features to achieve the optimal performance.

The combination of the three initials is **PAI**, similar to the circumference ratio, recalls how this design is related to the round shaped objects (BB pellets) and demonstrates the concept and function of this patent.

\*\*\*Only perfect roundness with 5.95mm diameter BB pellets paired with PAI patented Hop-Up chamber can achieve the best range and accuracy, choose G&G high quality BBs for the optimal performance.

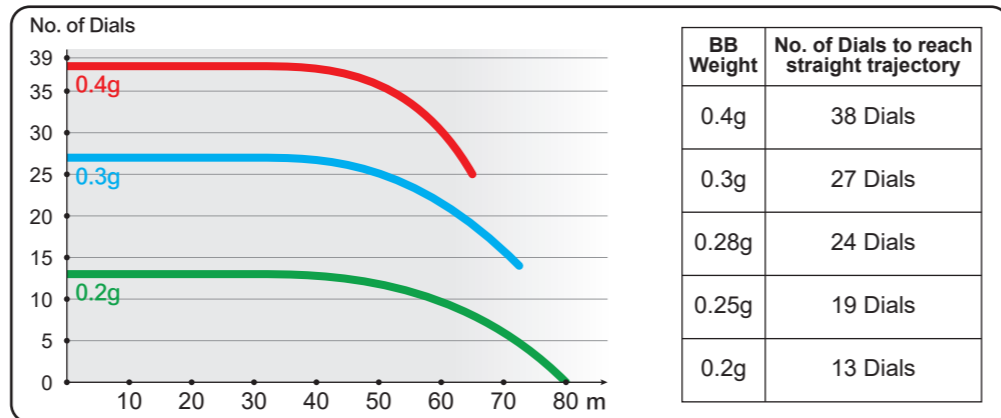

## STP45 PRO SERIES



**STP45 PRO 8"**  
GAS-STP-P80-BBB-ECM

LENGTH / 203 mm  
WEIGHT / 820 g  
MAGAZINE / 30 Rounds  
INNER BARREL / 104 mm

Design for PROS, dot sight ready, lightening cut CNC aluminum slide and CNC middle frame for durability and performance. Serration at the front and rear slide provide better grip when rack the slide. Patented Hop-Up units gives you the most accurate ballistics from 0.2g to 0.4g BB. The adjustment tool is hidden inside the recoil spring guide for both trigger and Hop-Up unit provides you easy access and fast adjustment without disassemble the slide or change tools. STP45 PRO series comes with 3 different length and all compatible with Marui parts.



**STP45 PRO 7.4"**  
GAS-STP-P74-BBB-ECM

LENGTH / 188 mm  
WEIGHT / 780 g  
MAGAZINE / 30 Rounds  
INNER BARREL / 87.4 mm



**STP45 PRO 8.7"**  
GAS-STP-P87-BBB-ECM

LENGTH / 221 mm  
WEIGHT / 880 g  
MAGAZINE / 30 Rounds  
INNER BARREL / 119.3 mm



**STP45 PRO GREY 8"**  
GAS-STP-P80-ABB-ECM

LENGTH / 203 mm  
WEIGHT / 820 g  
MAGAZINE / 30 Rounds  
INNER BARREL / 104 mm

# STP45 SERIES



**STP45**  
GAS-STP-045-BBB-ECM  
LENGTH / 203 mm  
WEIGHT / 840 g  
MAGAZINE / 30 Rounds  
INNER BARREL / 104 mm



**STP45 DST**  
GAS-STP-045-DBB-ECM  
LENGTH / 203 mm  
WEIGHT / 840 g  
MAGAZINE / 30 Rounds  
INNER BARREL / 104 mm



**STP45 MACARON BLUE**  
GAS-STP-045-IBB-ECM  
LENGTH / 203 mm  
WEIGHT / 840 g  
MAGAZINE / 30 Rounds  
INNER BARREL / 104 mm



STP45 Light Weight  
50R Magazine  
G-08-223 (GAS)  
G-08-225 (CO2)



STP45 30R Magazine  
G-08-222 (GAS)  
G-08-224 (CO2)

- ◆ **LIGHT-WEIGHT** ALUMINUM ALLOY CONSTRUCTION
- ◆ **DURABLE HARD-ANODIZED FINISH**

# 2024 CP SERIES



**2024 CP**  
GAS-224-CP8-BBB-ECM  
LENGTH / 215.4 mm  
WEIGHT / 760 g  
MAGAZINE / 30 Rounds  
INNER BARREL / 104 mm



**2024 CP BLACK/GOLD**  
GAS-224-CP8-KBB-ECM  
LENGTH / 206.7 mm  
WEIGHT / 760 g  
MAGAZINE / 30 Rounds  
INNER BARREL / 104 mm



**2024 CP GOLD**  
GAS-224-CP8-YBB-ECM  
LENGTH / 206.7 mm  
WEIGHT / 780 g  
MAGAZINE / 30 Rounds  
INNER BARREL / 104 mm



**2024 CP SILVER**  
GAS-224-CP8-SBB-ECM  
LENGTH / 206.7 mm  
WEIGHT / 740 g  
MAGAZINE / 30 Rounds  
INNER BARREL / 104 mm

Design for COMPETITION, dot sight ready, lightening cut CNC aluminum slide and CNC middle frame for speed and durability. 2024 CP offers fully ambidextrous slide release and safety. Integrated thumb rest and anti-slip texturing provides firm grip and control. Patented Hop-Up units gives you the most accurate ballistics from 0.2g to 0.4g BB. The adjustment tool is hidden inside the recoil spring guide for both trigger and Hop-Up unit provides you easy access and fast adjustment without disassemble the slide or change tools. 2024 CP series comes with 3 different lightening cut slides and all compatible with Marui parts.



A lighter weight, dot sight ready polymer slide and CNC middle frame version of STR45 that offers great performance without breaking your pockets. Same as the STP45 PRO series, the STP45 gives you the same features and compatibility with Marui parts. STP45 comes with matching slide and grip in different colors to choose from.



# LEVAR MODERN LEVER ACTION RIFLE



## LEVAR 15

GAS-LVR-015-BNB-ECM

LENGTH / 1019.3 mm  
MAGAZINE / 35 Rounds  
INNER BARREL / 425 mm

LevAR is a gas powered, lever action single shot modular platform that is compatible with G&G AR style AEG upper receiver. It is also compatible with AEG Hop-Up units and inner barrel, so you do not have to worry about upgradability of this rifle. The LevAR comes with standard 35 rounds short magazine, but it can take any STANAG style AEG magazine or even drum magazine.

# EVOLUTION SHOTGUN BULLPUP 10-ROUND



## ESG B-10

GAS-ESG-B10-BBB-ECM

LENGTH / 560.4 mm  
WEIGHT / 3140 g  
MAGAZINE / 105 Rounds  
INNER BARREL / 200 mm

The ESG B-10 is the evolutionary Bullpup style single barrel 5 or 10-round shotgun powered by gas and takes AEG magazine. A CNC and hard-anodized aluminum hand guard comes with M-LOK slot at 3 and 9 o'clock position that gives you the flexibility to mount accessories. The lower hand guard can be removed and reveal the picatinny rail for a vertical grip or a grenade launcher.

# GTW91 GBBR SERIES



## GTW91 GBB 2.0

GAS-T91-020-BBB-ECM

LENGTH / 806.7 mm  
WEIGHT / 3600 g  
MAGAZINE / 30 Rounds  
INNER BARREL / 350.5 mm

The GTW91 GBB series is the replica of Taiwanese Army issued rifle. With the same weight distribution and control, it is a perfect training tool for shooting. Adapting the MGCR system, this gas blowback rifle offers durability and guaranteed performance. Both 2.0 and 3.0 comes with 3-round burst feature exactly the same as the army standard T91 battle rifle.



## GTW91 GBB 3.0

GAS-T91-030-BBB-ECM

LENGTH / 806.7 mm  
WEIGHT / 3590 g  
MAGAZINE / 30 Rounds  
INNER BARREL / 350.5 mm

A CNC and hard-anodized aluminum hand guard comes with M-LOK slot at 3, 6 and 9 o'clock position that gives you the flexibility to mount accessories.

The 4-Positin fire control group including Safe, Fire, 3-Round burst and Auto.

The light weight aluminum bolt carrier and reinforced nozzle with double Teflon seals.



# GAME MASTER SERIES



## TR16 GMS MK1 9"

TGR-GMS-MK1-090-NCM

LENGTH / 755.3 mm  
WEIGHT / 2680 g  
MAGAZINE / 30 Rounds  
INNER BARREL / 320 mm

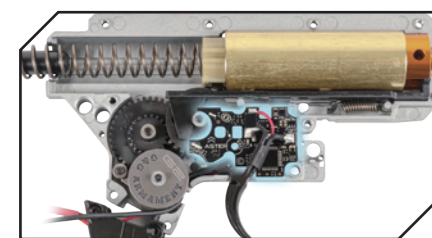

The GMS series is the first collaboration between GATE from Poland and G&G Armament. The entire series will be pre-installed with GATE Aster ETU and reinforced MIG gearbox. The new lower receiver provides room for quick change spring guide to go through from the buffer tube and ambidextrous safety control.



Dual-Profile Fiber Optic Flip-up Sight  
G-03-261



GOM V4 30R Magazine with Dummy Rounds  
G-08-227



## TR16 GMS MK2 7"

TGR-GMS-MK2-070-NCM

LENGTH / 604.3 mm  
MAGAZINE / 30 Rounds  
INNER BARREL / 205 mm



## TR16 GMS MK2 13.5"

TGR-GMS-MK2-135-NCM

LENGTH / 830 mm  
WEIGHT / 2910 g  
MAGAZINE / 30 Rounds  
INNER BARREL / 380 mm



## TR16 GMS MK2 15"

TGR-GMS-MK2-150-NCM

LENGTH / 871.4 mm  
WEIGHT / 2980 g  
MAGAZINE / 30 Rounds  
INNER BARREL / 425 mm



## TR16 GMS MK3 10.5"

TGR-GMS-MK3-105-NCM

LENGTH / 738.7 mm  
WEIGHT / 3140 g  
MAGAZINE / 125 Rounds  
INNER BARREL / 304 mm



NEWEST | 09

POWERED BY GATE  
ASTER

ADVANCED



POWERED BY GATE  
ASTER

ADVANCED



10 | NEWEST

# GBB GV2 ENGINE

TURN YOUR FAVORITE G&G AEG INTO A GBBR.

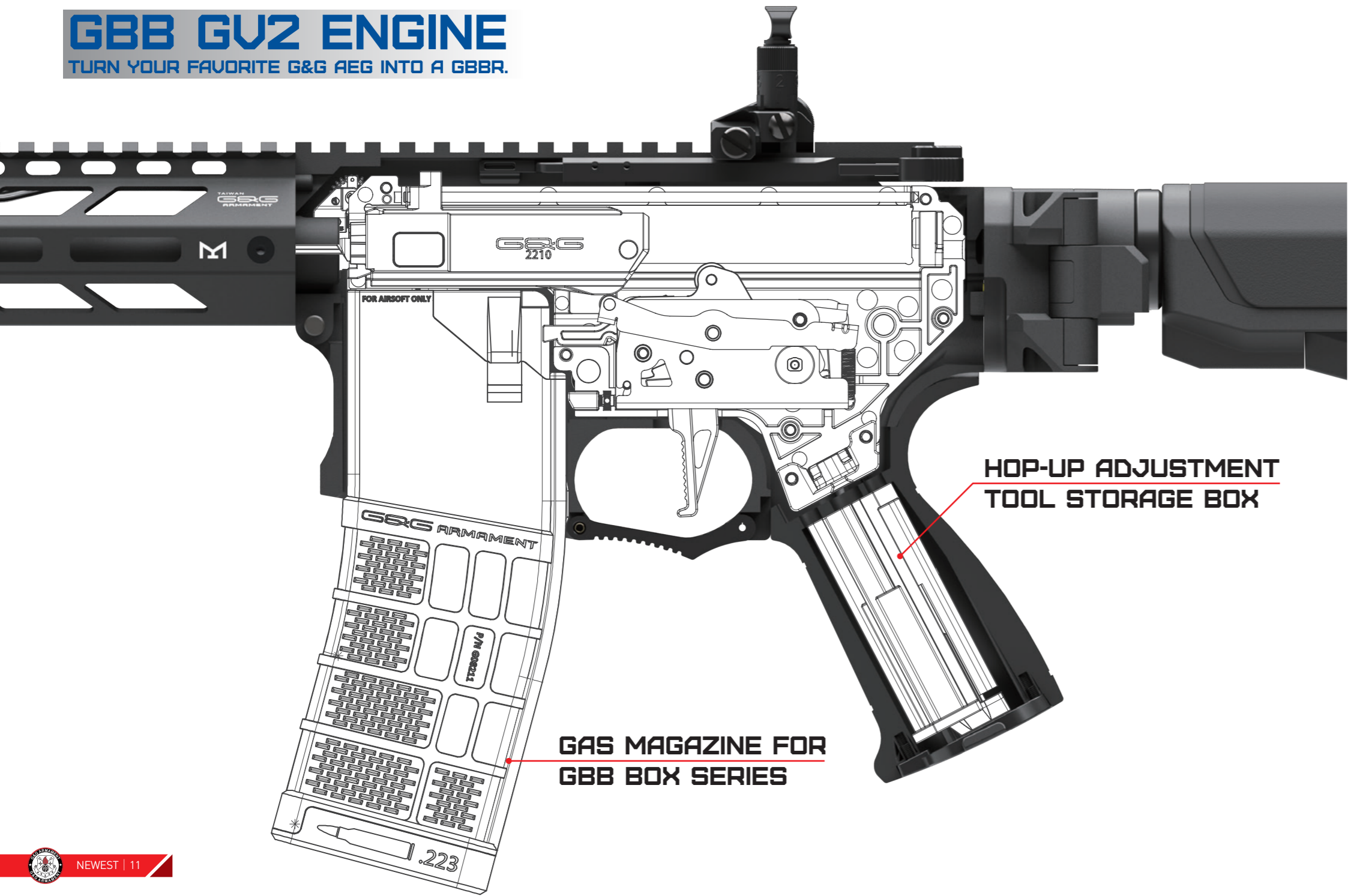

**HOP-UP ADJUSTMENT  
TOOL STORAGE BOX**

**GAS MAGAZINE FOR  
GBB BOX SERIES**

# COMBAT MACHINE SERIES



## CM16 BATTO

EGC-16P-BTO-BNB-NCM

LENGTH / 682.8 mm  
MAGAZINE / 120 Rounds  
INNER BARREL / 260 mm



Dual-Profile Fiber Optic  
Flip-up Sight  
[G-03-261](#)

The legendary Combat Machine series has come back with more features and new designs. The new polymer lower receiver provides room for quick change spring guide to go through from the buffer tube and ambidextrous magazine release. New features including functional bolt catch and quick change spring with upgraded steel bushing, 6.04mm brass precision inner barrel, rotary Hop-Up chamber and dual profile folding fiber optic sights.



# FOLDING AR SERIES



252.8mm



Dual-Profile Fiber Optic  
Flip-up Sight Macaron Blue  
[G-03-261-1](#)



Dual-Profile Fiber Optic  
Flip-up Sight Purple  
[G-03-261-2](#)



ARP9 68R Smoke  
Transparent Magazine  
[G-08-213](#)



ARP9 68R Macaron  
Blue Magazine  
[G-08-213-1](#)



ARP9 68R Pink  
Purple Magazine  
[G-08-213-2](#)



**FAR 9**  
EGC-FAR-9MM-BNB-NCM

LENGTH / 675 mm  
WEIGHT / 2090 g  
MAGAZINE / 68 Rounds  
INNER BARREL / 205 mm



**FAR 9  
MACARON BLUE**  
FAR-9MM-MAC-INB-NCM

LENGTH / 675 mm  
WEIGHT / 2090 g  
MAGAZINE / 68 Rounds  
INNER BARREL / 205 mm



**FAR 9 PINK**  
FAR-9MM-PIK-PBB-NCM

LENGTH / 675 mm  
WEIGHT / 2090 g  
MAGAZINE / 68 Rounds  
INNER BARREL / 205 mm

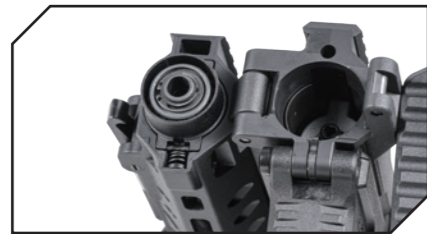

First in the market, folding AR 9mm series offer the compact design for conceal carrying and traveling. Light weight polymer construction only a bit more than 2 KGs that ease the burden when you carry it over the fields.





# ELECTRONIC TARGET SYSTEM



• Electronic target unit can also connect to other devices such as, Booby Trap and/or Auto Turret to build a shooting range simulates different scenarios.

## BOOBY TRAP



## AUTO TURRET

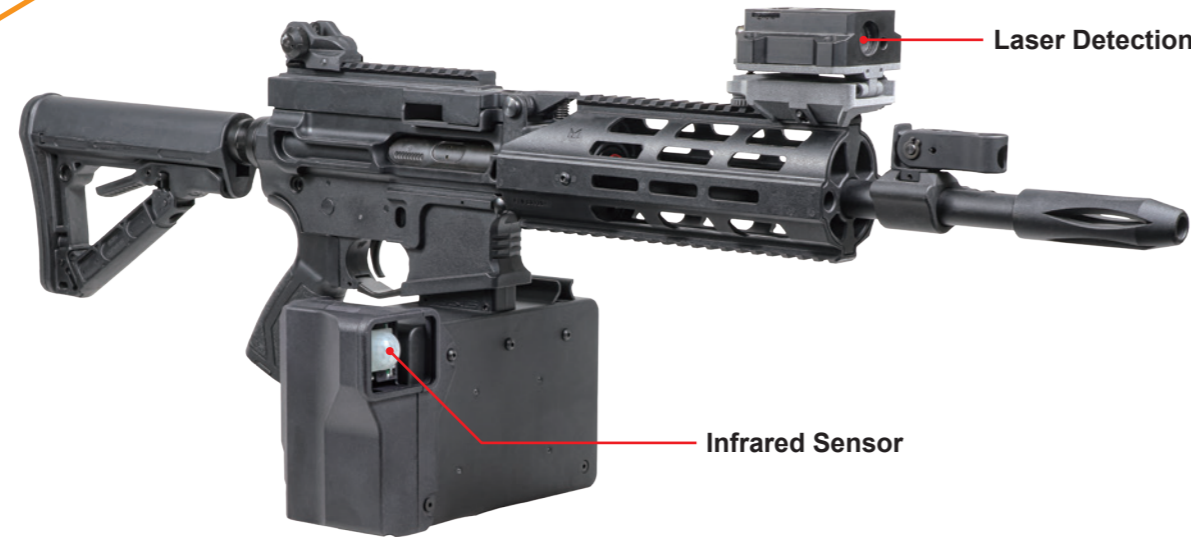

# World First Wireless Electronic Target System

**100% Wireless Connection** - Use SUB-1G industrial grade radio frequency.

**Limitless range expansion** - Wireless HUB units to extend the signal range.

**MEMS vibration sensor** - Only picks up the specific shock wave from BBs hit the target.

## Wireless Electronic Training Target Signal Connection Diagram

The maximum distance between each device is approximately 150 meters.

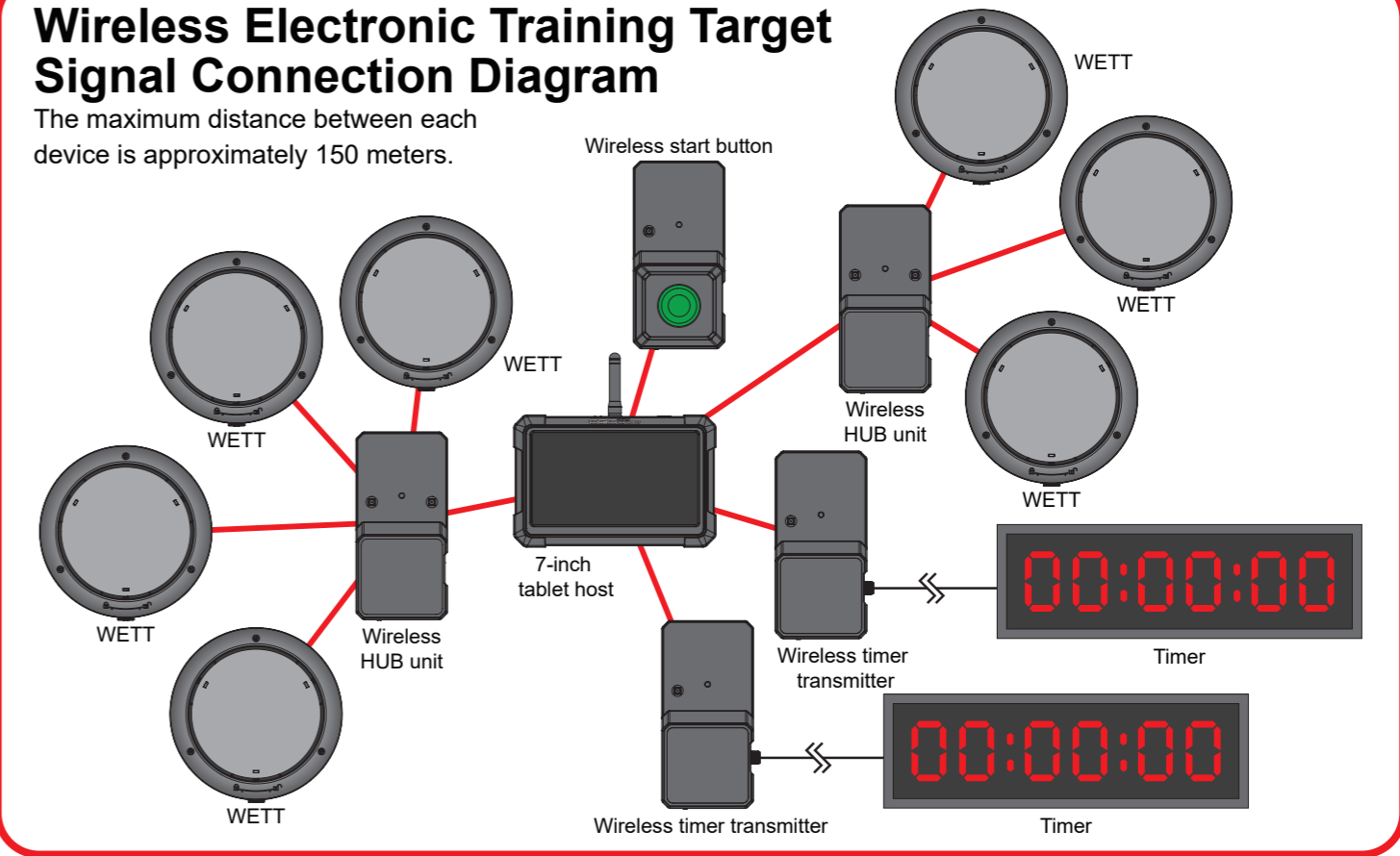

# E.T.T. ELECTRONIC TRAINING TARGET

The second generation of electronic target system now comes with steel target face with MEMS sensor with build-in 8 different modes for different training scenarios. The sensor will only pick up the specific shock wave when BBs hit the target, no misread or activate the target by accidentally bump into the target by hands or guns.

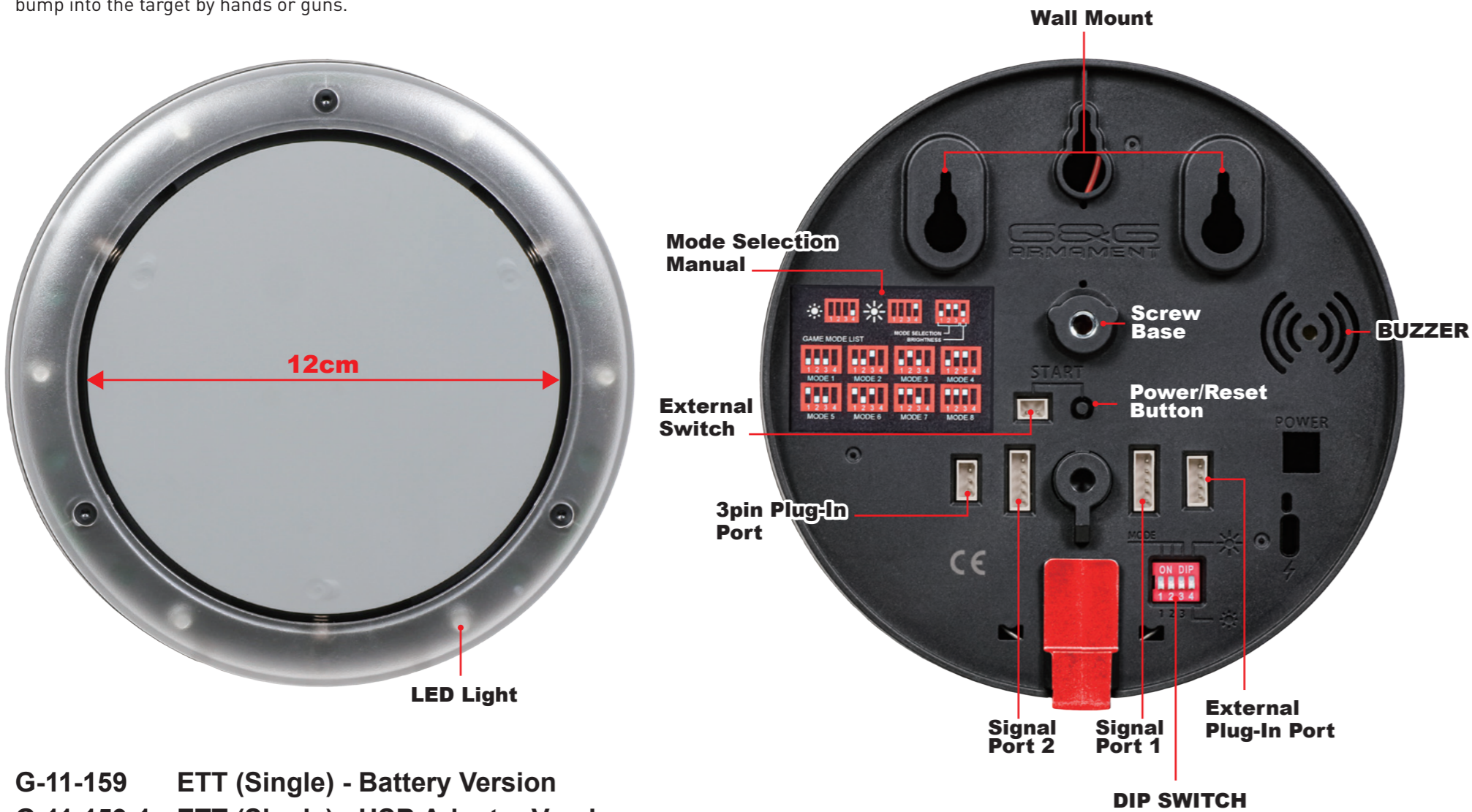

G-11-159 ETT (Single) - Battery Version  
 G-11-159-1 ETT (Single) - USB Adapter Version

# I.R. E.T.T.

The Infrared Ray electronic target system is perfect for night time or night vision training. The IR LED can only be seen through night vision devices. This system works both indoor and outdoor fields gives you the most flexibility in shooting range setups.

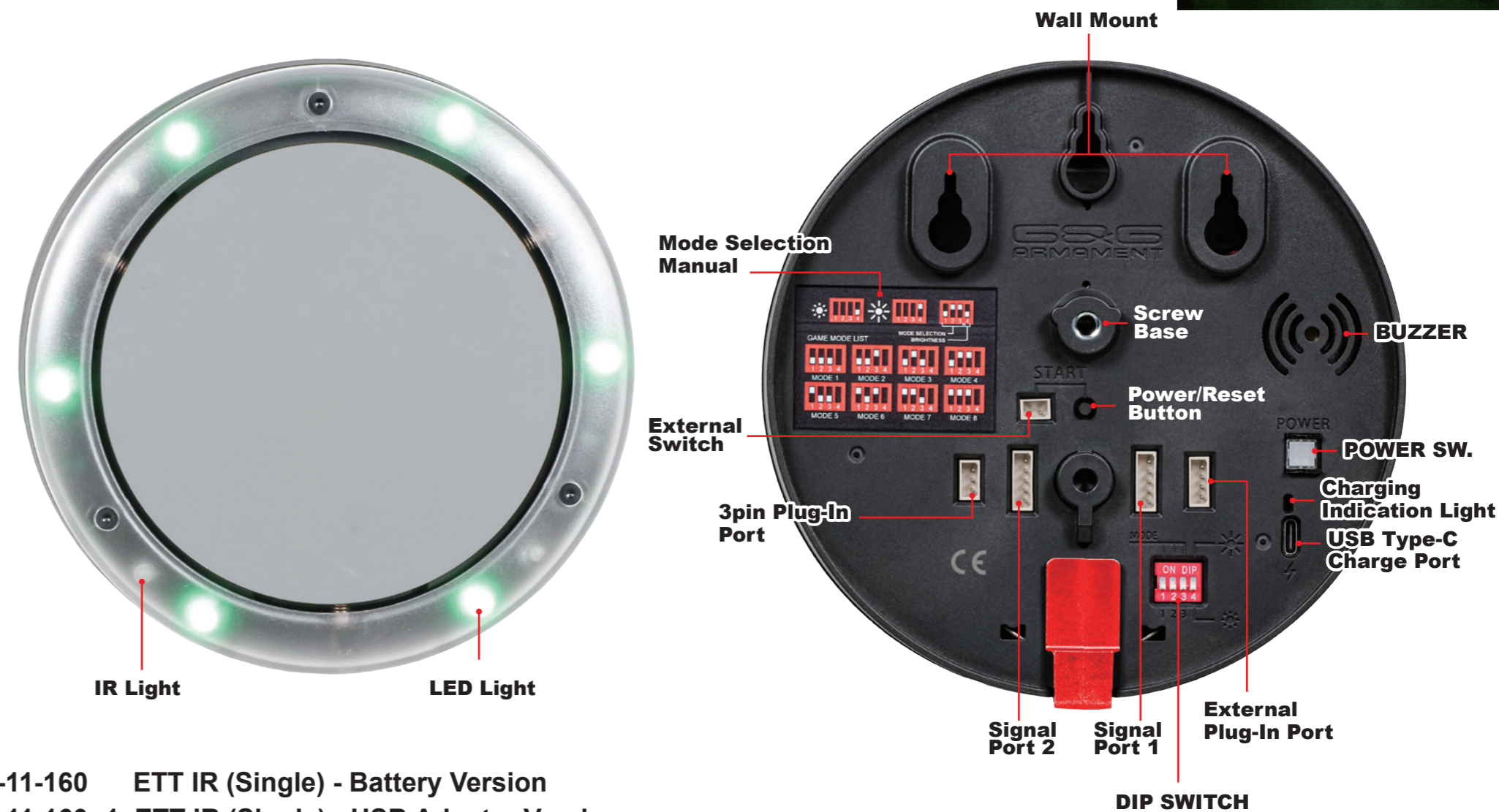
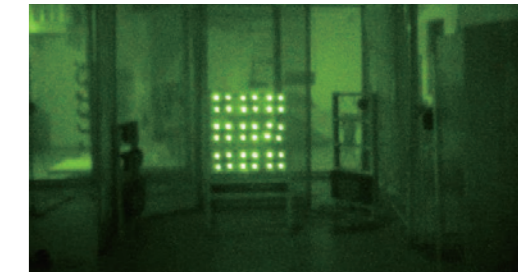

G-11-160 ETT IR (Single) - Battery Version  
 G-11-160 -1 ETT IR (Single) - USB Adapter Version



# MATRIX TARGET PACKAGE



**1 3X2 TARGET SYSTEM**  
(TIMER EXCLUDED)  
G-11-169 (75x101x61cm)  
G-11-170 (75x101x61cm)(IR ETT)



**2 3X2 TARGET SYSTEM**  
(TIMER INCLUDED)  
G-11-169-1 (75x101x61cm)  
G-11-170-1 (75x101x61cm)(IR ETT)



**3 3X3 TARGET SYSTEM**  
(TIMER EXCLUDED)  
G-11-167 (75x127x61cm)  
G-11-168 (75x127x61cm)(IR ETT)



**4 3X3 TARGET SYSTEM**  
(TIMER INCLUDED)  
G-11-167-1 (75x127x61cm)  
G-11-168-1 (75x127x61cm)(IR ETT)



**5 5X5 TARGET SYSTEM**  
(TIMER EXCLUDED)  
G-11-165 (120x180x82cm)  
G-11-166 (120x180x82cm)(IR ETT)



**6 5X5 TARGET SYSTEM**  
(TIMER INCLUDED)  
G-11-165-1 (120x180x82cm)  
G-11-166-1 (120x180x82cm)(IR ETT)



**G-11-161**  
ETT Precision Shooting Cover - 2cm  
**G-11-162**  
ETT Precision Shooting Cover - 4cm  
**G-11-163**  
ETT Precision Shooting Cover - 8cm

**STAY TUNED FOR MORE UPCOMING ACCESSORIES.**

# 8 CHALLENGE MODES

**Different challenge mode can only be selected when 2 or more ETTs are connected.**

## 1) Competition Mode

After Mode 1 selected, press the [Start Button] to start the challenge. In this mode, ETT will stand-by with green lights on. When the ETT received the shot, lights will turn red and stay in red until reset by pressing the [Start button] again. This mode is suggested in "quick draw" style competition.

## 2) Versus Mode

After Mode 2 selected, press the [Start Button] to start the challenge. In this mode, ETT will flash in green lights and count down 5 seconds by flashing once per second. After 5 seconds passed, the ETT will stay in green and ready to receive the shot. After ETT being shot, the lights will turn red and stay in red until reset by pressing the [Start Button] again. This mode is suggested in "showdown" style competition.

## 3) Search & Destroy Mode

After Mode 3 selected, press the [Start Button] to start the challenge. In this mode, ETT will stay in green lights and emit sounds. The sound will stop and ETT turns red after received a shot then switch on another ETT in random order if connected with others. This mode is suggested to set up with multiple ETTs and place them in random locations for shooters to find the ETTs.

## 4) Practice Mode

After Mode 4 selected, press the [Start Button] to start the challenge. In this mode, ETT will stay in green lights and ready to receive shots. The ETT will turn red and emit one sound after received a shot. If the range is set up with multiple ETTs, the last ETT will flash in red three times and emit a sound after received a shot to signal this challenge is over. This mode is suggested in any style of competition when shooters can easily spot the ETT.

## 5) Random Mode

After Mode 5 selected, press the [Start Button] to start the challenge. In this mode, ETT will stay in green lights and ready to receive shots. The ETT will turn red after received a shot and one of the other ETTs will light up in random order. If the ETT has not receive any shot under 1.5 seconds, then lights off and one of the other ETTs will light up in random order. When the last ETT received a shot, then it will flash red three times and turns off. This mode is suggested in any style of competition when shooters can easily spot the ETT.

## 6) Hostage Rescue Mode

After Mode 6 selected, press the [Start Button] to start the challenge. In this mode, ETT will change between green and red lights within 1.5 seconds. When ETT received a shot under green lights, it will emit a sound then turns off, but when it received a shot under red lights, it will stays in red without emit any sound. If ETT was connected with others, then the last ETT received a shot under green light will flash three times and the challenge is over. To start another run, press [Start Button] again to reset the game. This mode is suggested in "hostage scenario simulation" style competition.

## 7) Time Bomb Mode

After Mode 7 selected, press the [Start Button] to start the challenge. In this mode, ETT will change from green to red lights then turns off after received a shot, then randomly switch on another ETT if connected with others. If any ETT has not received a shot within 3 seconds, then ETT will turn red and stays in red to signal this challenge is over, until reset by pressing [Start Button] again. This mode is suggested in "extreme time limit" style competition.

## 8) Twins Mode

After Mode 8 selected, press the [Start Button] to start the challenge. In this mode, Random two ETTs will stay in green lights and ready to receive shots. These two ETTs must receive a shot under 1.5 seconds or they will switch to any other two ETTs in random order. When the last ETT received a shot, then it will flash three times with red lights to signal this challenge is over. This mode is suggested in any style of competition if there are two or more shooters.



October 2023

## 4th WORLD CUP CQB SHOOTING COMPETITION

WORLD CUP EXTREME SHOOTING COMPETITION is organized by G&G Armament and held in Taiwan. As the largest international shooting competition, G&G has been promoting the competition around the world since 2012.

70 competitors from 25 different countries qualified for the third World Cup competition in 2019, including USA, Canada, Chile, Brazil, Mexico, Bolivia, Colombia, UK, France, Germany, Spain, Poland, Romania, Switzerland, Netherlands, Finland, Italy, Denmark, Sweden, Czech Republic, Israel, New Zealand, Hong Kong, Japan and Taiwan.

The 4th World Cup Final successfully completed in October 2023 in Taiwan with total of 34 teams from 26 different countries. We are deeply appreciate the support from the enthusiasts and contestants, we could not have done it without you!!



2023 CHAMPION - NETHERLANDS

Dionne Janell Reugebrink  
David Meuken



2023 SECOND PLACE - CZECH REPUBLIC

Jiri Hoffman  
Ladislav Zekucia



2023 THIRD PLACE - ITALY

Francesco Maria De Gaetano  
Franco Zorzini



# World Cup CQB Record



2015 CQB Record	1'18"99	郭晉愷	王信彭	Team Taiwan
2017 CQB Record	1'39"32	Fernando Rogers	Gomez Valdes	Team Chile
2019 CQB Record	1'19"76	Luuk Stappaerts	Mark Van Ooijen	Team Netherlands
2023 CQB Record	2'04"54	Dionne Janell Reugebrink	David Meuken	Team Netherlands



2023 World Cup of CQB shooting competition opening ceremony



G&G CEO, James Liao promotes airsoft gun for years. During 2023 World Cup of CQB shooting competition, he brought all players to visit Presidential Office and had a picture with Taiwanese President, Vice President, Secretary-General. (Standing (left to right): Champion Team, G&G CEO James Liao, Taiwanese President, Vice President, Secretary-General, Second Place Team)



G&G CEO, James Liao took picture with R.O.C President, TSAI ING-WEN.



Former R.O.C President, MA YING-JIU tried out Military / Law Enforcement Training System



# SHOW YOURSELF 2023

Photo Contest



Racoon Squad / AUSTRIA



White Horse Cavalry II / Russia



RQS Team / Poland



Adam Aljović / Poland



Marcin Maternik / Scotland





Roddy / Poland



Last Shot Production / Italy

# SHOW YOURSELF 2023

## Photo Contest



Sorokin Alexander / Russia



Szymon Kamiński / Poland



Scioattoli / Italy



Andreas Weissgerber / Austria



5th Concordian Regiment / Netherlands



JOSE\_DANIEL\_DELMONTE / Spain



Anubis airsoft / Colombia



Piotr Partyk / Poland



Culto di Mitra / Italy

**Best Video Award**

YOUR GREATEST GLORY 2023 Video Contest

TOTAL PRIZES UP TO 30,000 USD  
Deadline 31.12.2023

TITLE | ON CLOUD NINE APPLICANT | BALAZS STARK COUNTRY | HUNGARY



**Nominated Masterpiece Award**

Team Up | Szymon Kamiński | POLAND

**Nominated Masterpiece Award**

ON THE BATTLEFIELD, ONLY THE EXTRAORDINARY PREVAILS | Julian Sarmiento | COLOMBIA

**Nominated Masterpiece Award**

THE SHADOW | Adam Aljović | POLAND

**Best Creative Award**

average size

TITLE | SIZE DOESN'T MATTER APPLICANT | MARCIN MATERNIK COUNTRY | UK



**Nominated Masterpiece Award**

are you ready?

BEYOND IMAGINATION | Luiggi Spaudo | ECUADOR

**Nominated Masterpiece Award**

PIERCE THROUGH THE SILENCE | Balazs Stark | HUNGARY

**Nominated Masterpiece Award**

CONGRATULATIONS  
TARGETS: 10/10  
YOU WON THE MAIN PRIZE!

WORTH PLAYING | Adam Aljović | POLAND

**Best Commercial Award**

TITLE | 4GLORY APPLICANT | BARTOSZ BIELICKI COUNTRY | POLAND

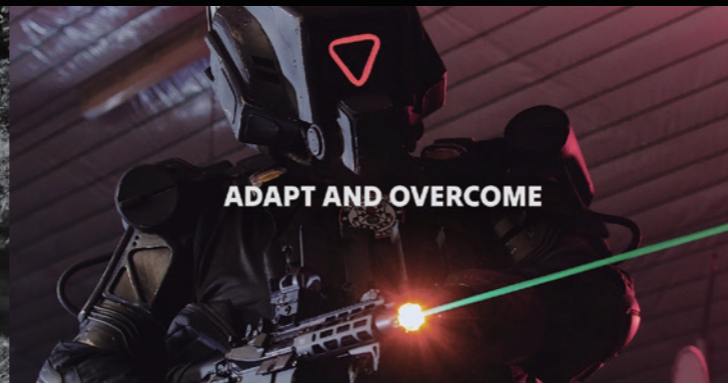

# YOUR GREATEST GLORY 2023

## Video Contest

Total Prize **USD\$20,000**,  
and many of G&G's airsoft guns.

We are waiting for you to participate  
on December 31, 2024 (UTC+8).

\*Please refer to the official website for detailed rules and awards.



G-01-064



FREE !!  
TRACER BBs 0.2G



# MF122T

## Muzzle Flash Tracer Unit



Green Tracer BBs Only!



TRICOMP  
(Trident steel compensator)  
[G-02-118](#)



Wind Breaker Flash hider  
[G-02-119](#)



S-Series TYPE 7 Steel Flash hider  
[G-02-120](#)



S-Series TYPE 8 Steel Flash hider  
[G-02-121](#)



S-Series TYPE 9 Steel Flash hider  
[G-02-122](#)



S-Series TYPE 10 Steel Flash hider  
[G-02-123](#)



S-Series TYPE 11 Steel Flash hider  
[G-02-124](#)



S-Series TYPE 12 Steel Flash hider  
[G-02-125](#)



S-Series TYPE 13 Steel Flash hider  
[G-02-126](#)



S-Series TYPE 14 Steel Flash hider  
[G-02-127](#)



S-Series TYPE 15 Steel Flash hider  
[G-02-128](#)



S-Series TYPE 16 Steel Flash hider  
[G-02-129](#)

# LUCKY DRAW 2024 GRAND PRIZE

# GMG42



**SELL G&G AND WIN G&G**  
**BUY G&G AND WIN G&G**  
Register your gun tag for a chance to win a free rifle.



ggarmament



ggarmament



@ggarmament



@ggarmament



Monthly Lucky Draw

**TAIWAN**

G3-202402-01 英

Sales Dept. sales@guay2.com , b2b@guay2.com  
Customer Support Dept. support@guay2.com  
PR Dept. pr@guay2.com

**ChangHua**  
(Headquarter)

Tel : +886-4-798-9000 Fax : +886-4-798-9900  
No.999, Zhonghua Rd. Shengang Township,  
Changhua County 50952, Taiwan (R.O.C.)

Dealer

[ Show Yourself 2021  
\*Silver Prize & Creative Prize ]  
Bartosz Bielecki / POLAND