

GR16 CARBINE PLASTIC

GR16 CARBINE DST PLASTIC



G&G ARMAMENT www.Guay2.com



[COMPONENTS]

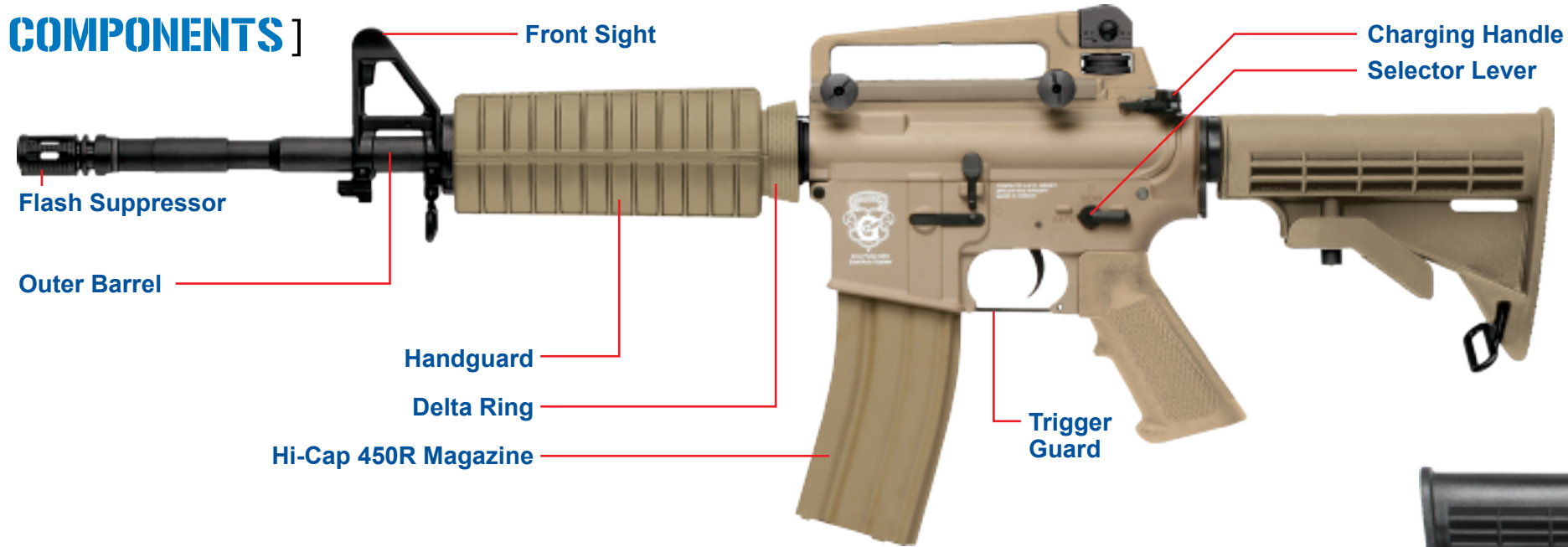

INSTRUCTION MANUAL



[FIRING MODE & SAFETY]

! Always keep the safety on if not ready to shoot.



Safety On / The gun will not fire.

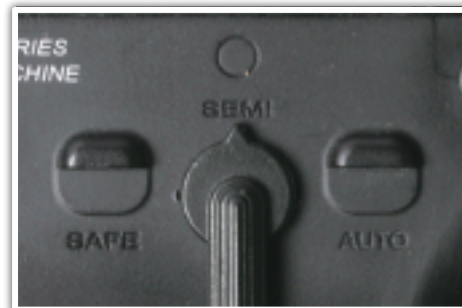

Semi Auto / Single shot.

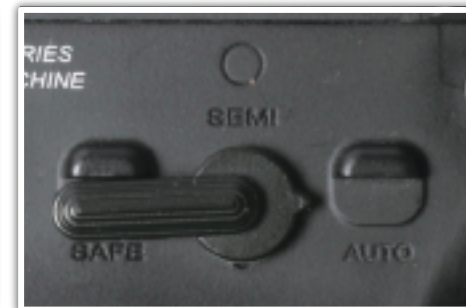

Full Auto / Automatic firing.

- Product is intended for adults 18 years and older.
- Wear proper eye protection while shooting.
- Misuse may cause injury or death.
- The muzzle of an airsoft gun should never point in a direction in which, if discharged, it would do injury.
- Read this entire manual to ensure proper usage.
- Buyers and users should obey the laws and rules of the local authority.

[BATTERY SETTING]

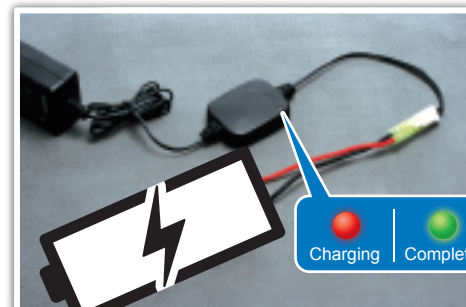

Charge up the battery (3 hours).

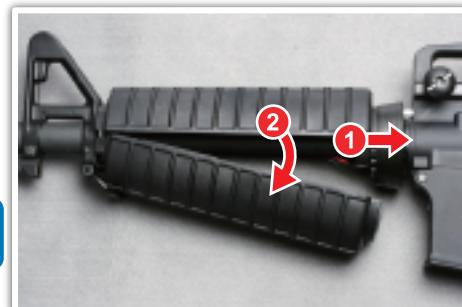

1. Pull the slip ring and hold.
2. Disassemble the lower handguard.

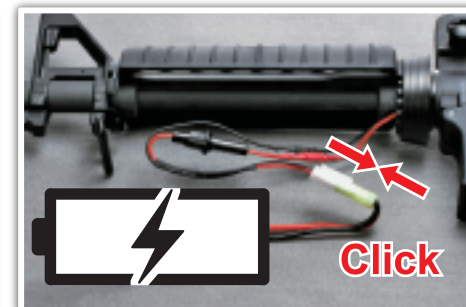

Connect battery plug with the connector.

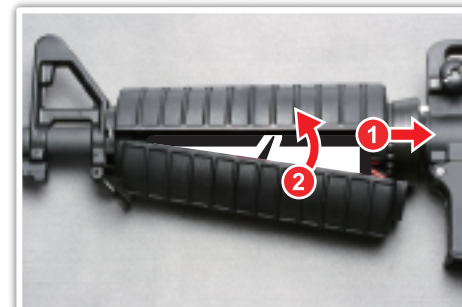

1. Pull the slip ring and hold.
2. Reinstall the lower handguard.

[CHARGING HANDLE & HOP-UP ADJUSTMENT]



Pulling the charging handle will take the bolt back and open the port cover.

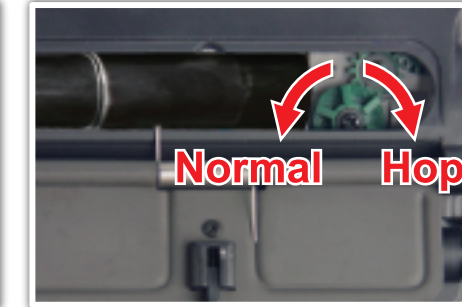

! Don't catch your fingers in the dummy bolt. Never hold the gun sideways as the BB pellets will curve right or left.

[SETTING MAGAZINE]



Open the magazine top plate.



Load BBs into the chamber and close the plate when the chamber is full.



Close the cover plate then turn the gear until the sound changes.



Insert the magazine into the airsoft gun until it clicks into place.

- **Too much Hop-up.** (Turn the adjust lever toward Normal)
- **Not enough Hop-up.** (Turn the adjust lever toward Hop)

Best Position.



[CRANE STOCK ADJUSTMENT]



Press the stock release lever to unlock.

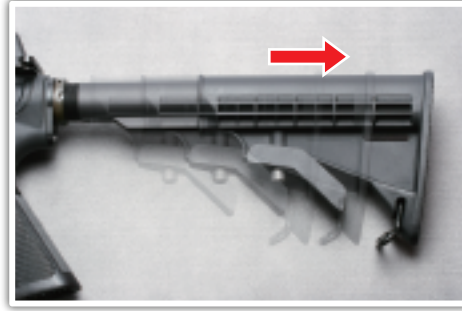

6 position retractable stock.

[FRONT SIGHT & REAR SIGHT ADJUSTMENT]



Turning clockwise:
Raises the pellet hitting point.
Turning counterclockwise:
Lowers the pellet hitting point.

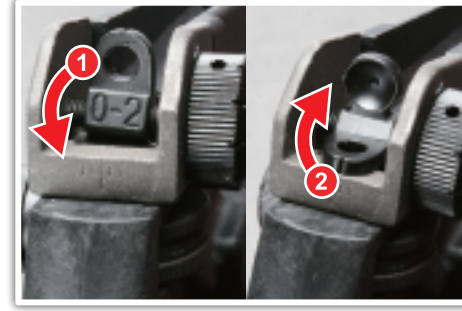

1. For precision shooting.
2. For normal shooting.

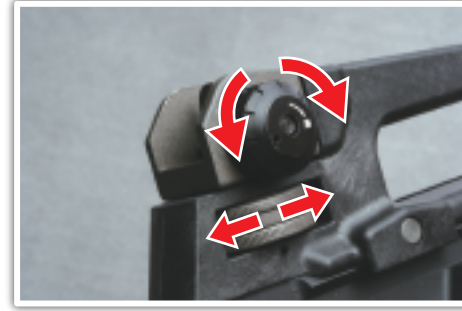

Windage knob:
for Rear Sight left / right adjustment.
Elevation knob:
for Rear Sight up / down adjustment.

[MOVABLE PARTS]



Turn the knobs counterclockwise and take off the carrying handle.



Dot sight (optional).

You can buy other accessories to install on the rail system.

[TROUBLE SHOOTING]



Adjust screw when the gear noise becomes shrilly.

Use a screwdriver to adjust the screw at the bottom of the grip.



No operation.

Check the fuse.



No operation.

Check the wire set contact with motor.

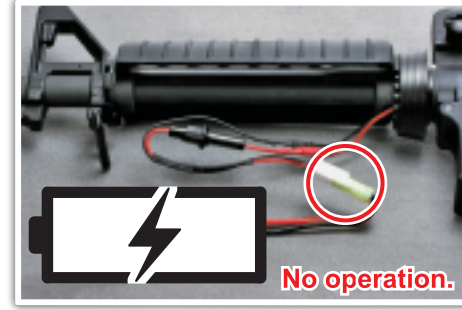

No operation.

Check the battery & connector.

[UNJAM]



Remove the magazine.

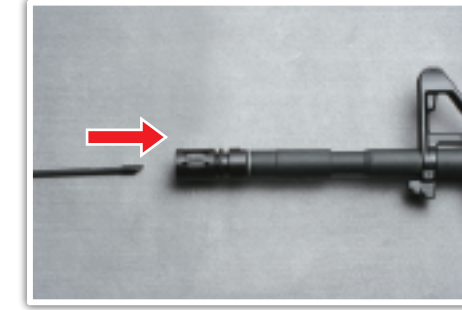

Return the hop up dial to normal position and insert the cleaning rod from the lead edge of the inner barrel.

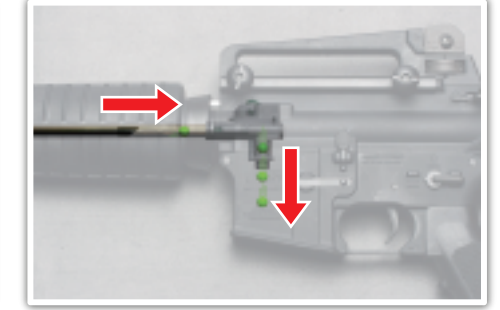

Be sure to have the rod facing down and reaching to the end. Remove clogged pellets.

[PARTS LIST]

- 01 Wire Set
- 02 Charging Handle Set
- 03 Dummy Bolt
- 04 Buffer Tube Set
- 05 Retractable Stock Set
- 06 Motor Set
- 07 Grip Set
- 08 Gear Box Set
- 09 Upper Receiver Set
- 10 Magazine
- 11 Handguard Set
- 12 Delta Ring
- 13 Hop-Up Set
- 14 Dummy Gas Tube
- 15 Outer Barrel Set
- 16 Front Sight
- 17 Flash Suppressor Set
- 18 Lower Receiver Set
- 19 Detachable Carrying Handle
- 20 Rear Sight Set

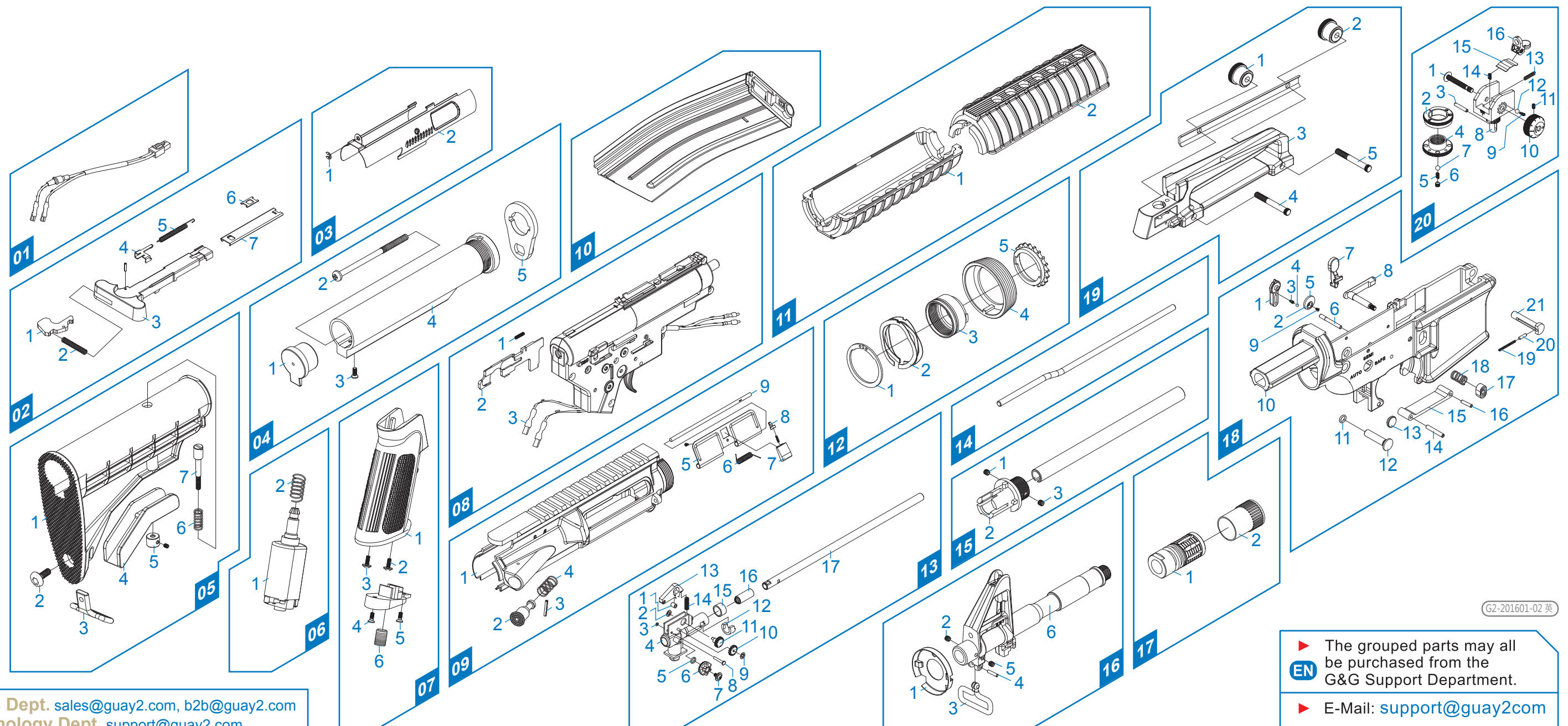

TAIWAN ChangHua (Headquarter)

Tel: +886-4-798-9000 Fax: +886-4-798-9900
No. 999, Zhonghua Rd. Shengang Township,
Changhua County 50952, Taiwan (R.O.C.).

Sales Dept. sales@guay2.com, b2b@guay2.com
Technology Dept. support@guay2.com
PR Dept. pr@guay2.com

G2-201601-02 英

▶ The grouped parts may all be purchased from the G&G Support Department.
▶ E-Mail: support@guay2.com