

GF85

6mm Electric Semi/Full Auto System

INSTRUCTION MANUAL

Address

No.999, Zhonghua Rd., Shengang Township,
Changhua County 50952, TAIWAN

E-Mail

Sales Department / sales@guay2.com b2b@guay2.com

Technology support Department / support@guay2.com

Website

www.guay2.com

TEL

+886-4-798-9000

Fax

+886-4-798-9900



G&G ARMAMENT
AIRSOFT GUNS & ACCESSORIES



G&G ARMAMENT
AIRSOFT GUNS & ACCESSORIES



GF85

6mm Electric Semi/Full Auto System

INSTRUCTION MANUAL

This product is intended for users 18 years or older.
Read all instructions before using this product.

MANUFACTURED BY G&G ARMAMENT
100% MADE IN TAIWAN WWW.GUAY2.COM

WARNING

⚠ Adult supervision required. Always wear safety goggles when using this product. Misuse or careless handling of this product may cause injury. May be hazardous up to 50 meters.



You may be liable for damaging public or personal property or for injuring a person or an animal even if you only meant to shoot as a "practical joke." Always observe good manners and enjoy fun sport shooting.



Never direct the muzzle towards a person, animal or in any direction. That may cause harm or damage to the third party.



Select a safe place for operating the air gun, avoid places where people and cars are around.



Make sure to put the barrel and safety cap on the muzzle, except when you are shooting. Do this to prevent accident, discharge of BBs and also for dust protection purpose. Never pull the trigger while the barrel and the safety cap is attached.



Safety procedures:
1. Attach the safety cap to the muzzle.
2. Set the selector lever to the safety position.
3. Remove the magazine.
4. Remove the battery.



Looking into the muzzle is extremely dangerous regardless of BBs having been loaded or not. If you get hit in the eye by a BB pellet, you may in worst case, lose your eye sight.

WARNING

Operation of this air gun for competition use is restricted to users of 18 years old or more. Careless shooting and wrong operation are dangerous, causing eye damage or other injury.

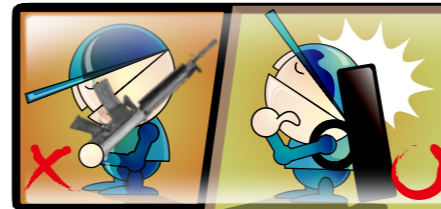

When you carry the air gun, attach the safety cap, set the selector lever to the safety position and always put the air gun in a case or bag.



Activating the trigger carelessly is extremely dangerous. Never put your finger on the trigger unless the safety cap is removed and you are ready to shoot a target.



When shooting the air guns for target practice or in a game situation, you and all participants must wear safety goggles or other eye protective gear. Also, pay attention to ricochets. It is very important to pay attention to third parties other than the participants.



There may be cases where some BBs remain in the gun after the magazine has been removed. After removal of the magazine, direct the muzzle towards a safe direction and pull the trigger to confirm that there are no BBs remain in the gun, then attach the safety cap.



Always attach the safety cap to the muzzle, remove the battery and store the air gun in a case or bag and at a place that is out of reach by children.



Disassembling or modifying the gun may adversely affect the performance and make it dangerous. " It may be against the Law."

CONTENTS

WARNING (P01.02)	SETTING MAGAZINE (P06)	HOP-UP ADJUSTMENT (P11)
COMPONENTS (P03)	SIGHT ADJUSTMENT (P07)	MAINTENANCE (P11)
SELECTOR & SAFETY SETTING (P04)	MOVABLE PARTS (P08)	TROUBLE SHOOTING (P12)
BATTERY SETTING (P05)	FIRING (P09.10)	PARTS LIST (P13.14)

COMPONENTS

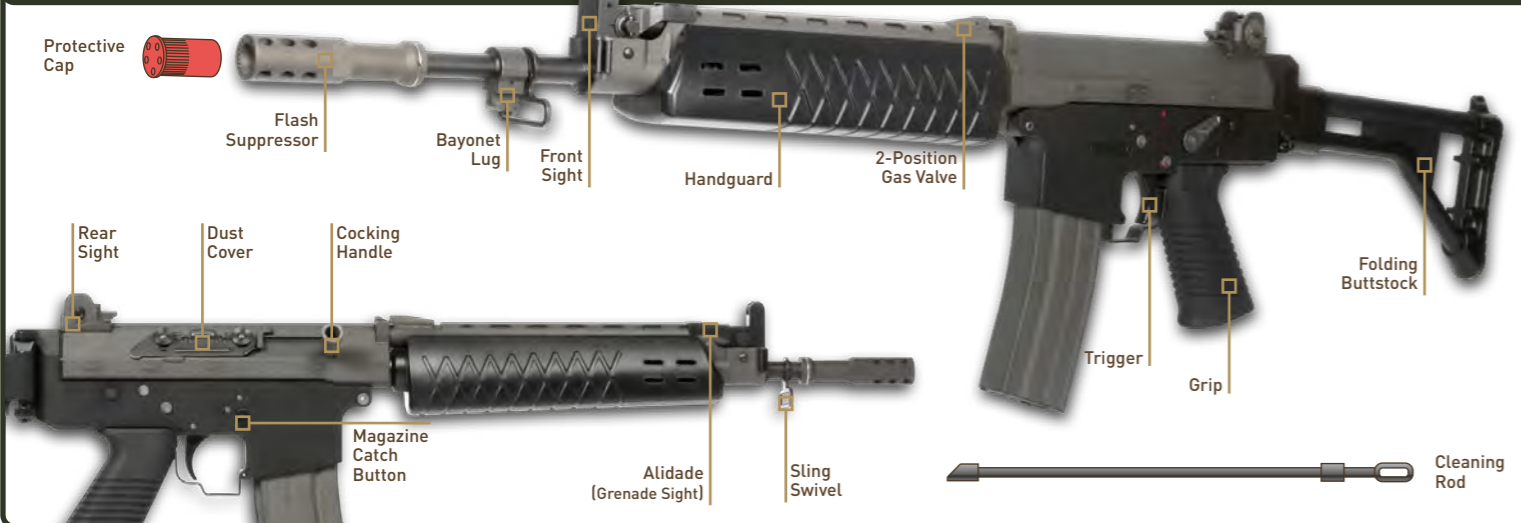

SELECTOR & SAFETY SETTING



SAFETY ON
THE TRIGGER CANNOT BE PULLED

When not firing the gun or during storage, always set the selector to the 'S' position and attach the protective cap on the muzzle.



SEMI AUTO
SINGLE SHOT

Selector to the '1' position. The gun will fire one shot each time when pulling the trigger.



FULL AUTO AUTOMATIC FIRING

Selector to the '3' or 'A' position. The gun will be fired automatically while the trigger remains being pulled.

CAUTION Never operate the Selector while pulled the trigger. Pull the trigger with the Selector being set at safe mode may damage the air gun.

CAUTION Set the selector in correct position; otherwise malfunction may occur.

BATTERY SETTING



Turn the selector to the Safety position. The magazine should be removed before.

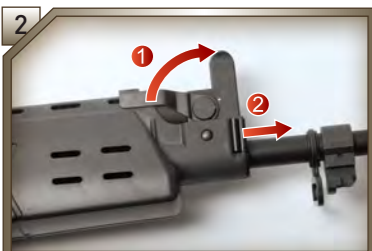

Turn up the alidade and push the handguard spring forward.

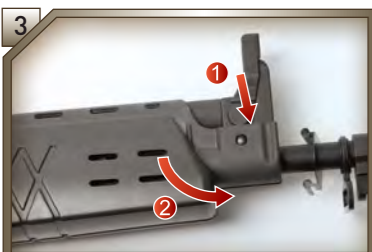

Push the pin then take off the handguard.

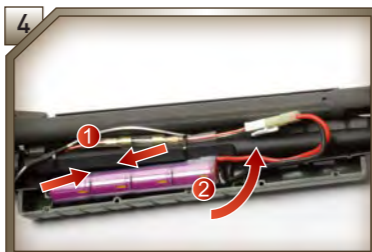

Connect battery plug with the connector then insert the battery into the handguard.



Reassembly the handguard.

RECOMMENDED BATTERY TYPE



G-11-019
NI-MH 9.6V 1400

CAUTION ■ Use only the G&G battery purchased from your local dealer.

SETTING MAGAZINE



Push the button to release the magazine.



Load G&G 5.95mm BB pellets into the magazine. The magazine is capable of holding approximately 450 pellets.

CAUTION

Always use the G&G BB pellet or diameter 5.94 ~ 5.96 mm BBs for this air gun. G&G shall not be held responsible for any damage or accidents arising from the use of pellets supplied by other manufacturers.

Confirm that the safety lever is set to the Safety position and do not place your finger on the trigger.



After the BB pellets had been loaded, close the cover and turn the gear on the bottom of the magazine until the sound changes.



Set the magazine upward.



Connect firmly till a click sound is heard.

SIGHT ADJUSTMENT

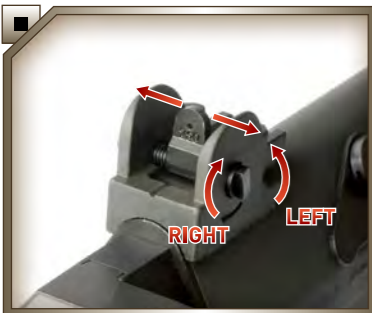

Turning clockwise: To correct the shots leaning to the left.
Turning counterclockwise: To correct the shots leaning to the right.

Rear Sight Adjustment



For common shooting



For precision shooting

Battle Sight (FLIP MANUALLY)

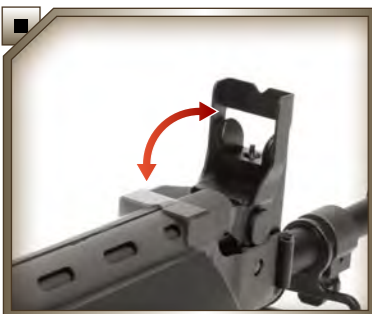

Flip-Up for aiming the rifle grenades.

Alidade (GRENADE SIGHT)



Turn the gas valve to fire rifle grenades. (Simulation)

Gas Valve (2-POSITIONS)

MOVABLE PARTS

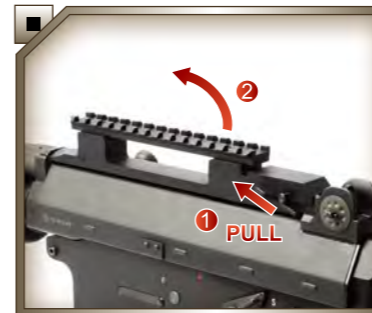

Detachable Scope Mount (OPTIONAL)



Pull up the lock pin to release the scope mount and take off.

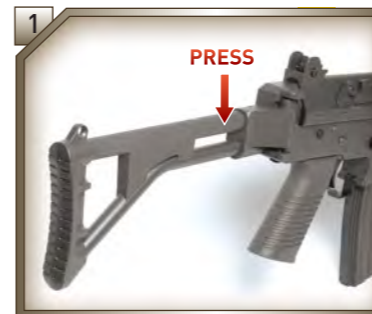

Foldable Stock



Press the stock and fold to right side of the gun.

FIRING



1 Make sure to install the magazine upwards and into the body. It had been installed properly when you heard a click sound.



2 Remove the protective cap only when you are ready for firing the gun.

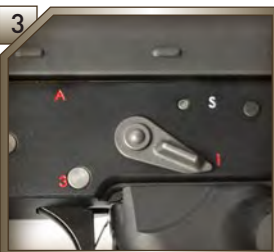

3 Set the Selector Lever to '1', '3' or 'A' position.

CAUTION

There are possible cases that no firing occurs after pulling the trigger in the semi auto mode. In such cases, do not pull the trigger furiously. Fire 5 to 6 shots in the full auto mode and then return to the semi auto operation.

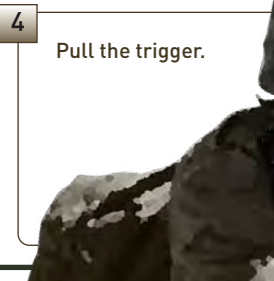

4 Pull the trigger.

Activating the trigger carelessly is extremely dangerous. Never place your finger on the trigger unless the protective cap is removed and you are ready to shoot a target. Blank firing may occur when triggered, this is the normal operation of the gun.

1 After Operation

Remove the magazine, direct the muzzle into a safe direction then fire the gun in semi-auto mode for a few shots. Set the selector to the safe position. Always disconnect the battery and attach the protective cap whenever you do not operate the air gun.

2 Cautions on Motor and Battery

Charge the battery if the firing cycle becomes slow. Give the air gun a rest for 5 to 10 minutes after firing about 500 rounds, in order to ensure long service lives of the motor and battery.

3 When Bullets Are Clogged

If bullets are clogged, remove them and apply a few drops of G&G silicone oil into the chamber from the magazine entrance. Apply G&G silicone oil for 0.5 to 1 sec, to obtain smooth continuous firing.

WARNING

Make sure no dirt gets into the chamber to avoid clogging of bullets. The hopping up operation may be unstable for 200 to 300 rounds after using silicone oil, this is the normal operation for the gun.



Never use CRC-556, WD40 or other corrosive lubricant.

HOP-UP ADJUSTMENT



Pull the cocking handle backward. Turning hop-up dial for adjusting the ideal flight pattern of the BB pellet. The hop-up dial can only be turned a certain amount. Turning too much will damage the unit.

CAUTION

Never hold the gun sideways as the BB pellets will curve right or left. This is due to the HOP-UP system.

Too much HOP-UP.
(Return the lever toward NORMAL)

Best position.

Not enough HOP-UP. (Move the lever toward HOP)
Or too much HOP-UP. (Return the lever toward NORMAL)

MAINTENANCE



Do not jam the cleaning rod into the barrel by force. Should the BB's remains inside the barrel after following the instruction above, with the protection cap over the barrel, point the gun to a safe direction and discharge any loosened BB's in semi-automatic mode.

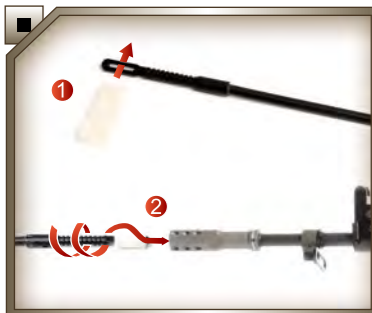

1. Drop a few drops of silicone oil or Teflon oil from the pellet entrance. Insert BB pellets into the magazine and fire around 1 to 2 magazines.
2. To complete the cleaning, use the cleaning rod (with cotton), to remove excess oil.

Maintenance When Bullet Speed Becomes Low

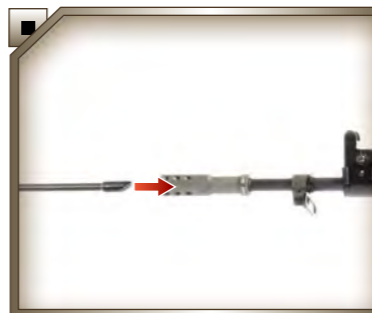

1. Return the hop up dial to the Normal position and insert the cleaning rod from the lead edge of the barrel.
2. To remove clogged BB's, carefully insert the cleaning rod inside the barrel with the flat tip facing down as shown below.

Removing Clogged Bullets

TROUBLE SHOOTING



When a problem occasion please check the steps below, other problems please turn to your dealer or contact us.

SYMPTOM	POTENTIAL	CORRECTIVE
No operation at all	Selector lever is set to safety.	Set the selector lever to Semi or Full Auto.
	Battery is not charged.	Charge the battery.
	Battery connector is disconnected.	Connect the connector.
Although motor is revolving, no pellet can be fired	The + and - of battery connector is reverse.	Connect the connector correctly (check the fuse)
	Expired motor life (50,000 to 60,000 rounds) or poor electrical connection.	Replace the dead motor (can be purchased from local dealer or directly G&G). Check and repair the contacts.
	Pellets are clogged inside the magazine.	Insert the charging rod into the magazine and move up and down a few times to remove clogged pellets.
Impossible full-auto operation (automatic firing)	Pellets are clogged in the chamber.	Remove clogged pellets using the cleaning rod.
	Faulty gear.	Purchase the replacement gear from your dealer or G&G and repair.
	Insufficient battery power.	Charge the battery.
Shooting distance becomes shorter	Faulty pellet feed of magazine.	Repair clogging of the magazine.
	Poor electrical connection.	Consult your dealer or us for overhaul maintenance or repair.
	Damaged or worn chamber set.	Replace the replacement parts (Purchasing from your dealer or G&G)
	Damaged or worn piston set (O-ring, piston spring)	Use the cleaning rod and clean the inner barrel.
	Something is jammed in the inner barrel	Use the genuine G&G Pellets.
Too loud operating noise	Faulty BB pellets (too small or heavy)	Use the G&G Pellets.
	Shrotage of silicone oil	Drops few drops of silicone oil from upper the chamber.
	Gear problem caused by too many blank firing	Consult your dealer or G&G for overhaul maintenance, part replacement (gear, etc.) or repair.
Pellets being fallen out from barrel end	Worn or damaged gear	Consult your dealer or G&G for overhaul maintenance, part replacement (gear, etc.) or repair.
	Gear problem caused by too many blank firing	Consult your dealer or G&G for overhaul maintenance, part replacement (gear, etc.) or repair.
If gun gets wet	Damaged or worn chamber set.	Replace the replacement parts (Purchasing from your dealer or G&G)
	No hop setting.	Turn the hop adjustment lever toward Hop.
	Faulty BB Pellets (too small or heavy)	Use the G&G Pellets.
	Stop operation immediately, disconnect the battery, wipe off water from inside the main body and the battery. After completely dry, carry out trial firing. If the unit is not operational, please contact your local dealer for repair.	

DISCLAIMER

- Accessories pictured are not always included with product.
- Adult supervision required for users under 18 years of age.
- The purchaser and user should conform to all laws governing and ownership of airsoft guns.
- All products in this manual are imitation firearms and are not intended nor represented to be comparable in design, appearance, or function to any actual firearm offered by other manufacturers.
- Product names are trademarks of G&G, which has no affiliation to, and is not associated, or sponsored by any manufacturer of actual or imitation firearms. Products may vary from those pictured.

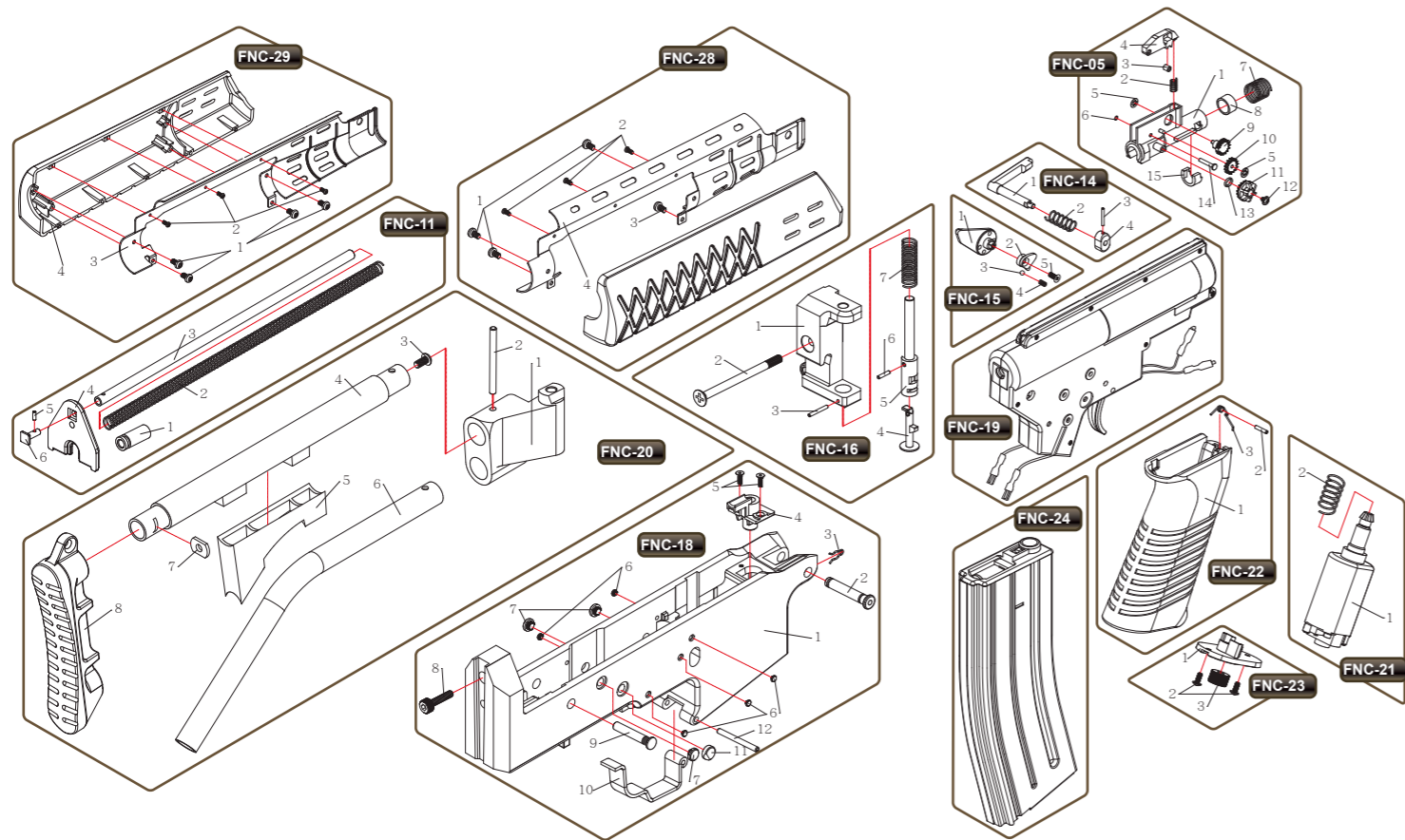

PARTS LIST

No.	Parts Name
FNC-01	Flash Suppressor Set
FNC-02	Front Sight Set
FNC-05	Hop-Up Set
FNC-06	Upper Receiver Set
FNC-07	Dust Cover Set
FNC-08	Scope Mount Set
FNC-09	Dummy Bolt Set
FNC-10	Inner Barrel Set
FNC-11	Recoil Spring Set
FNC-12	Outer Barrel Set
FNC-13	Gas Piston Sleeve
FNC-14	Magazine Catch Set
FNC-15	Selector Lever Set
FNC-16	Stock Support Housing
FNC-17	Gas Valve Set
FNC-18	Lower Receiver Set
FNC-19	Gear Box Set
FNC-20	Folding Buttstock Set
FNC-21	Motor Set
FNC-22	Grip Set
FNC-23	Grip Bottom Plate Set
FNC-24	Magazine
FNC-25	Bayonet Lug Set
FNC-26	Front Sling Swivel Set
FNC-27	Handguard Clip
FNC-28	Handguard Set (Right Side)
FNC-29	Handguard Set (Left Side)

