

[CRANE STOCK ADJUSTMENT]

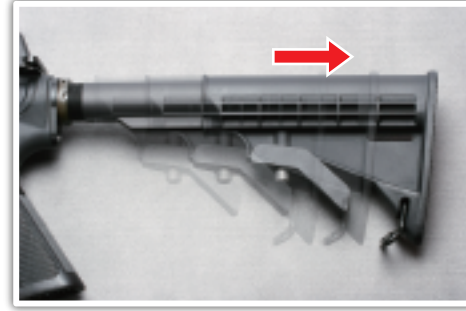

Press the stock release lever to unlock.



6 position retractable stock.

[FRONT SIGHT & REAR SIGHT ADJUSTMENT]



Turning clockwise:
Raises the pellet hitting point.
Turning counterclockwise:
Lowers the pellet hitting point.

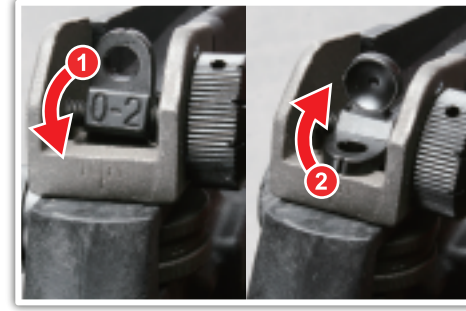

1. For precision shooting.
2. For normal shooting.

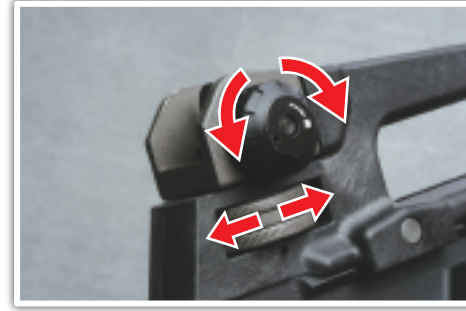

Windage knob:
for Rear Sight left / right adjustment.
Elevation knob:
for Rear Sight up / down adjustment.

[MOVABLE PARTS]

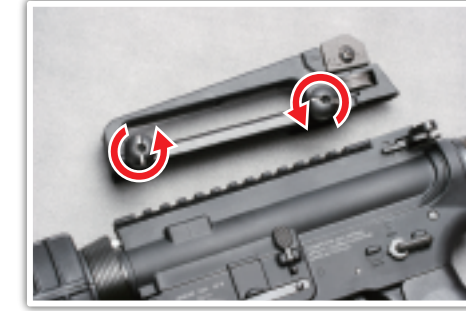

Turn the knobs counterclockwise and
take off the carrying handle.



Dot sight (optional).
You can buy other accessories to install
on the rail system.

[TROUBLE SHOOTING]



Adjust screw when the gear
noise becomes shrilly.
Use a screwdriver to adjust the screw
at the bottom of the grip.



No operation.

Check the fuse.



No operation.

Check the wire set contact with motor.

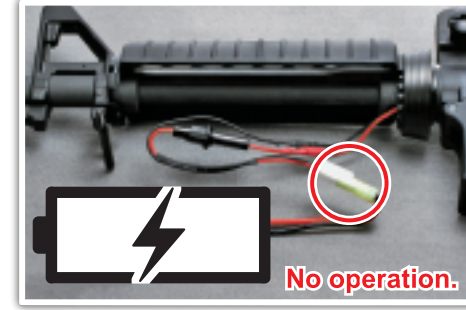

No operation.

Check the battery & connector.

[UNJAM]



Remove the magazine.

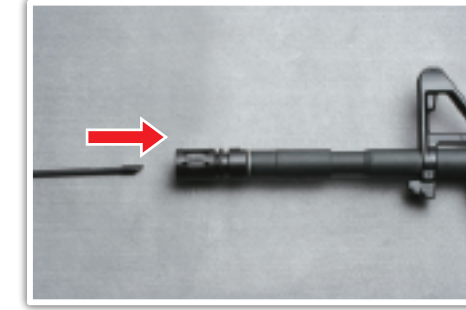

Return the hop up dial to normal position
and insert the cleaning rod from the lead
edge of the inner barrel.

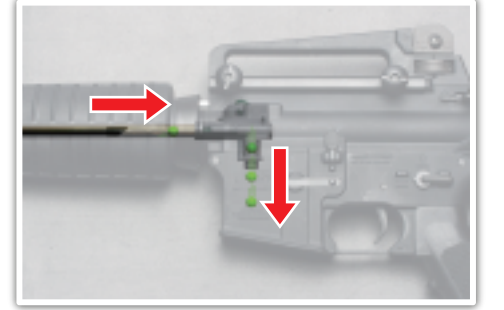

Be sure to have the rod facing down
and reaching to the end.
Remove clogged pellets.

[PARTS LIST]

- 01 Wire Set
- 02 Charging Handle Set
- 03 Dummy Bolt
- 04 Buffer Tube Set
- 05 Retractable Stock Set
- 06 Motor Set
- 07 Grip Set
- 08 Gear Box Set
- 09 Upper Receiver Set
- 10 Magazine
- 11 Handguard Set
- 12 Delta Ring
- 13 Hop-Up Set
- 14 Dummy Gas Tube
- 15 Outer Barrel Set
- 16 Front Sight
- 17 Flash Suppressor Set
- 18 Lower Receiver Set
- 19 Detachable Carrying Handle
- 20 Rear Sight Set

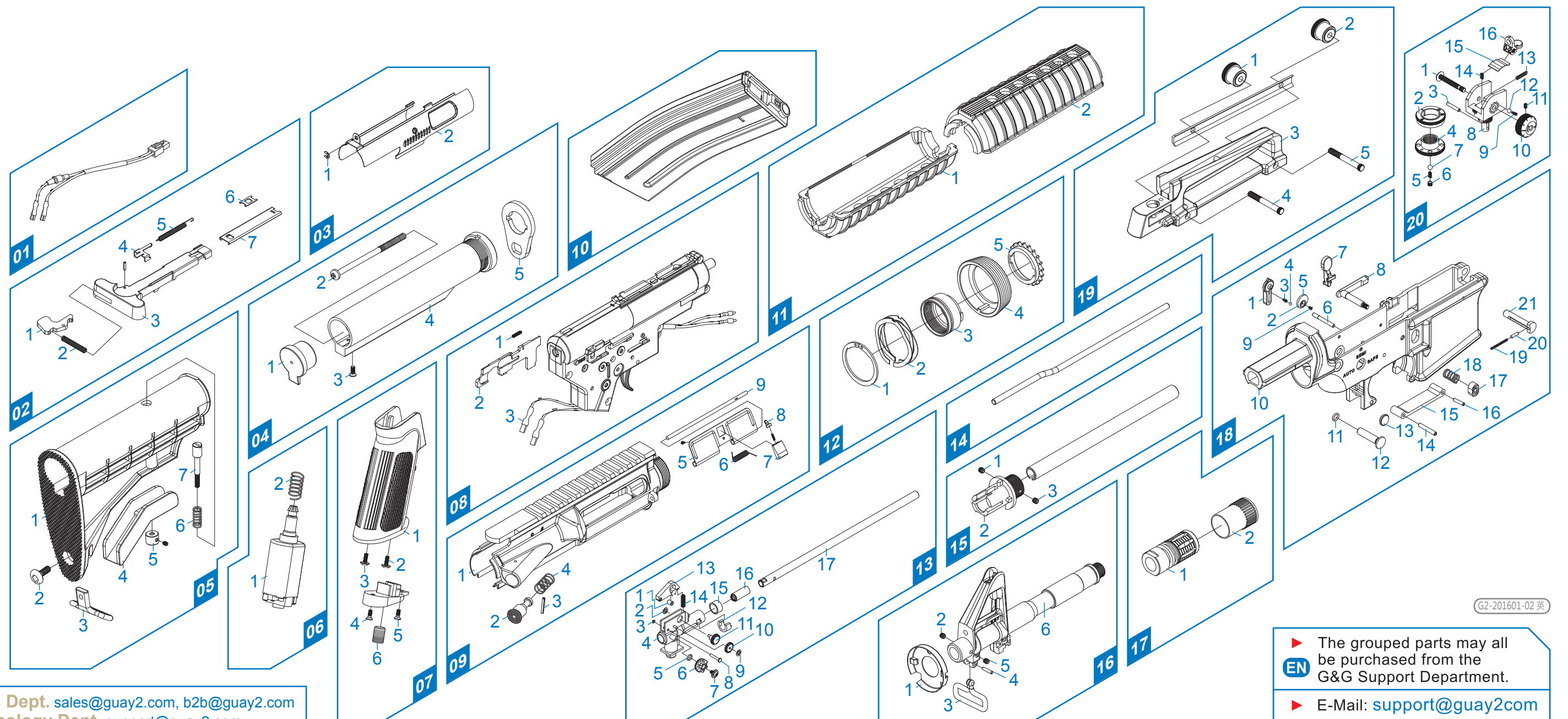

TAIWAN ChangHua (Headquarter)

Tel: +886-4-798-9000 Fax: +886-4-798-9900
No. 999, Zhonghua Rd. Shengang Township,
Changhua County 50952, Taiwan (R.O.C.).

Sales Dept. sales@guay2.com, b2b@guay2.com
Technology Dept. support@guay2.com
PR Dept. pr@guay2.com

G2-201601-02 英

▶ The grouped parts may all
be purchased from the
G&G Support Department.
▶ E-Mail: support@guay2.com